

RICE MCNAIR HALL PHASE 1.3 & 1.4

Location: Houston, Texas

Project Number: 002.8270.000

CH01

Created : 12/18/2018

2019/01/31 REVISION 2

Product Info

Manufacturer: Davis Furniture Industries

Product Name: Ginkgo

Attributes

Model #: GK1000

[DIMENSIONS]

Width: 21 1/4"

Depth: 21 5/8"

Overall Height: 32"

Seat Height: 17 7/8"

[FINISH]

Base: 402 Medium Walnut

Frame: Polished Aluminum

Notes

Four Leg Base
Armless / Mid Back
Maximum 6 stacking

#	Rooms	Quantity
120	Multipurpose Room	40
100	Multipurpose Room	40
138	Community Commons	7

Total: 87

Indicative Photo



REQUIREMENTS

1. Drawings are for reference only. See furniture plan(s) for configurations.
2. Submit drawings for approval prior to proceeding.
3. Furniture Vendor must provide installation drawings for approval prior to proceeding.
4. Furniture Vendor must submit in writing any deviations to above specifications prior to proceeding.
5. Furniture Vendor is responsible for verifying all quantities based on Gensler furniture plan(s) per issue date above.
6. All furniture must be tagged with room number locations.
7. Furniture vendor is responsible for confirming all item/model numbers per Gensler specifications.
8. Submit (1) finish sample for each specified item to Gensler for approval prior to fabrication.
9. Furniture Vendor shall certify that all products meet all regulations of the jurisdiction in which the project is located and includes required stamps, certification and labeling to meet local code requirements.
10. Fabric to be backed according to manufacturer's recommendations for specified application.
11. Furniture Vendor is responsible for confirming, extending, or establishing fabric reserves in appropriate quantities and to meet project schedule.

Houston, Texas

Gensler

Product Info

Manufacturer: Emeco Furniture

Product Name: EMECO BARSTOOL

Attributes

Model #: STOL-30

[DIMENSIONS]

Width: 14"

Depth: 14"

[FINISH]

Base: BRUSHED

Indicative Photo



#	Rooms	Quantity
138	Community Commons	14
		Total: 14

REQUIREMENTS

1. Drawings are for reference only. See furniture plan(s) for configurations.
2. Submit drawings for approval prior to proceeding.
3. Furniture Vendor must provide installation drawings for approval prior to proceeding.
4. Furniture Vendor must submit in writing any deviations to above specifications prior to proceeding.
5. Furniture Vendor is responsible for verifying all quantities based on Gensler furniture plan(s) per issue date above.
6. All furniture must be tagged with room number locations.
7. Furniture vendor is responsible for confirming all item/model numbers per Gensler specifications.
8. Submit (1) finish sample for each specified item to Gensler for approval prior to fabrication.
9. Furniture Vendor shall certify that all products meet all regulations of the jurisdiction in which the project is located and includes required stamps, certification and labeling to meet local code requirements.
10. Fabric to be backed according to manufacturer's recommendations for specified application.
11. Furniture Vendor is responsible for confirming, extending, or establishing fabric reserves in appropriate quantities and to meet project schedule.

Houston, Texas

RICE MCNAIR HALL PHASE 1.3 & 1.4

Location: Houston, Texas

Project Number: 002.8270.000

CH03

Created : 12/18/2018

2019/01/31 REVISION 2

Product Info

Manufacturer: Herman Miller

Product Name: Mirra 2 Chairs

Attributes

Model #: MRF-12

[DIMENSIONS]

Width: 30"

Depth: 18.5"

Overall Height: 42.75"- 38.75"

Seat Height: 16"- 20.5"

[FINISH]

Butterfly Back: Latitude Twilight

Seat : AireWeave 2 Twilight

Frame Base: 6KA

BLACK BASE

Indicative Photo



AireWeave 2 Twilight 1A708
by Herman Miller



Latitude Twilight 8M26
by Herman Miller

#	Rooms	Quantity
	REFER TO PLANS FOR LOCATION	38

REQUIREMENTS

1. Drawings are for reference only. See furniture plan(s) for configurations.
2. Submit drawings for approval prior to proceeding.
3. Furniture Vendor must provide installation drawings for approval prior to proceeding.
4. Furniture Vendor must submit in writing any deviations to above specifications prior to proceeding.
5. Furniture Vendor is responsible for verifying all quantities based on Gensler furniture plan(s) per issue date above.
6. All furniture must be tagged with room number locations.
7. Furniture vendor is responsible for confirming all item/model numbers per Gensler specifications.
8. Submit (1) finish sample for each specified item to Gensler for approval prior to fabrication.
9. Furniture Vendor shall certify that all products meet all regulations of the jurisdiction in which the project is located and includes required stamps, certification and labeling to meet local code requirements.
10. Fabric to be backed according to manufacturer's recommendations for specified application.
11. Furniture Vendor is responsible for confirming, extending, or establishing fabric reserves in appropriate quantities and to meet project schedule.

Houston, Texas

Gensler

RICE MCNAIR HALL PHASE 1.3 & 1.4

Location: Houston, Texas

Project Number: 002.8270.000

CH04

Created : 12/18/2018

2019/01/31 REVISION 2

Product Info

Manufacturer: Davis Furniture Industries

Product Name: Rhombus

Attributes

Model #: RH-1000

[DIMENSIONS]

Width: 21 7/8"

Depth: 22 7/8"

Overall Height: 33 3/8"

Seat Height: 18 1/4"

[FINISH]

Upholstery: DESIGNTEX 2711-414

Frame: 402 Medium Walnut

Indicative Photo



PIGMENT 2711-414 BLUEBELL
by DesignTex

#	Rooms	Quantity
	REFER TO PLANS FOR LOCATION	24

REQUIREMENTS

1. Drawings are for reference only. See furniture plan(s) for configurations.
2. Submit drawings for approval prior to proceeding.
3. Furniture Vendor must provide installation drawings for approval prior to proceeding.
4. Furniture Vendor must submit in writing any deviations to above specifications prior to proceeding.
5. Furniture Vendor is responsible for verifying all quantities based on Gensler furniture plan(s) per issue date above.
6. All furniture must be tagged with room number locations.
7. Furniture vendor is responsible for confirming all item/model numbers per Gensler specifications.
8. Submit (1) finish sample for each specified item to Gensler for approval prior to fabrication.
9. Furniture Vendor shall certify that all products meet all regulations of the jurisdiction in which the project is located and includes required stamps, certification and labeling to meet local code requirements.
10. Fabric to be backed according to manufacturer's recommendations for specified application.
11. Furniture Vendor is responsible for confirming, extending, or establishing fabric reserves in appropriate quantities and to meet project schedule.

Houston, Texas

Gensler

RICE MCNAIR HALL PHASE 1.3 & 1.4

Location: Houston, Texas

Project Number: 002.8270.000

LG01

Created : 12/18/2018

2019/01/31 REVISION 2

Product Info

Manufacturer: OFS Furniture

Product Name: Tangent - Modular

Attributes

Model #: REFER DIAGRAM BELOW

[DIMENSIONS]

Width: REFER PLAN BY LAYOUT

Depth: REFER PLAN BY LAYOUT

Seat Height: 18"

[FINISH]

Unit: UP07

Seat : UP05

Back Pillow: UP04

Notes

Refer to plan for layout & size.

#	Rooms	Quantity
138	Community Commons	1
		Total: 1

Indicative Photo



UP07
MAIN LINE FLAX TEMPLE MLF16
by Camira Fabrics



UP05
INFINITY ASTER
by Momentum Textiles

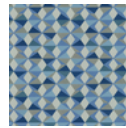

UP04
DIALOGUE 3471-944 COBALT
by Bernhardt Textiles

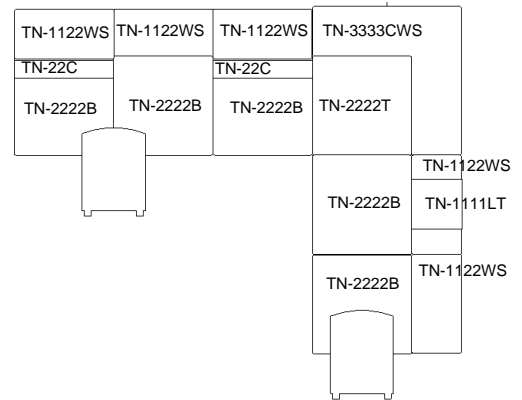

REQUIREMENTS

1. Drawings are for reference only. See furniture plan(s) for configurations.
2. Submit drawings for approval prior to proceeding.
3. Furniture Vendor must provide installation drawings for approval prior to proceeding.
4. Furniture Vendor must submit in writing any deviations to above specifications prior to proceeding.
5. Furniture Vendor is responsible for verifying all quantities based on Gensler furniture plan(s) per issue date above.
6. All furniture must be tagged with room number locations.
7. Furniture vendor is responsible for confirming all item/model numbers per Gensler specifications.
8. Submit (1) finish sample for each specified item to Gensler for approval prior to fabrication.
9. Furniture Vendor shall certify that all products meet all regulations of the jurisdiction in which the project is located and includes required stamps, certification and labeling to meet local code requirements.
10. Fabric to be backed according to manufacturer's recommendations for specified application.
11. Furniture Vendor is responsible for confirming, extending, or establishing fabric reserves in appropriate quantities and to meet project schedule.

Houston, Texas

RICE MCNAIR HALL PHASE 1.3 & 1.4

Location: Houston, Texas

Project Number: 002.8270.000

LG02

Created : 12/18/2018

2019/01/31 REVISION 2

Product Info

Manufacturer: OFS Furniture

Product Name: Tangent - Modular

Attributes

Model #: REFER DIAGRAM BELOW

[DIMENSIONS]

Width: REFER PLAN BY LAYOUT

Depth: REFER PLAN BY LAYOUT

Seat Height: 18"

[FINISH]

Unit: UP07

Seat : UP05

Back Pillows: UP04

Notes

Refer to plan for layout and size.

#	Rooms	Quantity
138	Community Commons	1
		Total: 1

Indicative Photo



UP07
MAIN LINE FLAX TEMPLE MLF16
by Camira Fabrics



UP05
INFINITY ASTER
by Momentum Textiles

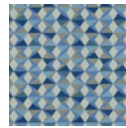

UP04
DIALOGUE 3471-944 COBALT
by Bernhardt Textiles

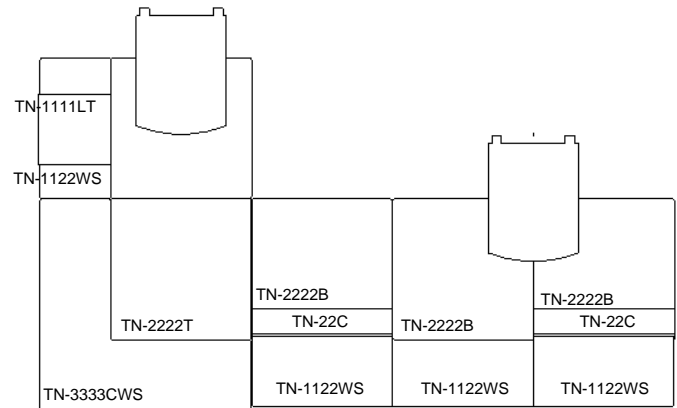

REQUIREMENTS

1. Drawings are for reference only. See furniture plan(s) for configurations.
2. Submit drawings for approval prior to proceeding.
3. Furniture Vendor must provide installation drawings for approval prior to proceeding.
4. Furniture Vendor must submit in writing any deviations to above specifications prior to proceeding.
5. Furniture Vendor is responsible for verifying all quantities based on Gensler furniture plan(s) per issue date above.
6. All furniture must be tagged with room number locations.
7. Furniture vendor is responsible for confirming all item/model numbers per Gensler specifications.
8. Submit (1) finish sample for each specified item to Gensler for approval prior to fabrication.
9. Furniture Vendor shall certify that all products meet all regulations of the jurisdiction in which the project is located and includes required stamps, certification and labeling to meet local code requirements.
10. Fabric to be backed according to manufacturer's recommendations for specified application.
11. Furniture Vendor is responsible for confirming, extending, or establishing fabric reserves in appropriate quantities and to meet project schedule.

Houston, Texas

Gensler

RICE MCNAIR HALL PHASE 1.3 & 1.4

Location: Houston, Texas

Project Number: 002.8270.000

LG03

Created : 12/18/2018

2019/01/31 REVISION 2

Product Info

Manufacturer: OFS Furniture

Product Name: Lona

Attributes

Model #: 94117

[DIMENSIONS]

Width: 29.5"

Depth: 32"

Overall Height: 38.5"

Seat Height: 18"

Arm Height:

[FINISH]

Legs/Base: Brushed Nickel Base

Upholstery: UP06

Notes

High Back with Wrap Around Headrest

#	Rooms	Quantity
138	Community Commons	1
		Total: 1

Indicative Photo



UP06

INFINITY BEYOND

by Momentum Textiles

REQUIREMENTS

1. Drawings are for reference only. See furniture plan(s) for configurations.
2. Submit drawings for approval prior to proceeding.
3. Furniture Vendor must provide installation drawings for approval prior to proceeding.
4. Furniture Vendor must submit in writing any deviations to above specifications prior to proceeding.
5. Furniture Vendor is responsible for verifying all quantities based on Gensler furniture plan(s) per issue date above.
6. All furniture must be tagged with room number locations.
7. Furniture vendor is responsible for confirming all item/model numbers per Gensler specifications.
8. Submit (1) finish sample for each specified item to Gensler for approval prior to fabrication.
9. Furniture Vendor shall certify that all products meet all regulations of the jurisdiction in which the project is located and includes required stamps, certification and labeling to meet local code requirements.
10. Fabric to be backed according to manufacturer's recommendations for specified application.
11. Furniture Vendor is responsible for confirming, extending, or establishing fabric reserves in appropriate quantities and to meet project schedule.

Houston, Texas

Gensler

RICE MCNAIR HALL PHASE 1.3 & 1.4

Location: Houston, Texas

Project Number: 002.8270.000

LG04

Created : 12/18/2018

2019/01/31 REVISION 2

Product Info

Manufacturer: Arcadia Furniture

Product Name: Nios® Lounge

Attributes

Model #: 2554

[DIMENSIONS]

Width:

Depth:

Overall Height:

Seat Height:

Arm Height:

[FINISH]

Legs/Base: WOOD

Body/Shell: UP06

Indicative Photo

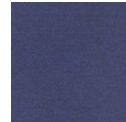

UP06

INFINITY BEYOND

by Momentum Textiles

#	Rooms	Quantity
138	Community Commons	6
		Total: 6

REQUIREMENTS

1. Drawings are for reference only. See furniture plan(s) for configurations.
2. Submit drawings for approval prior to proceeding.
3. Furniture Vendor must provide installation drawings for approval prior to proceeding.
4. Furniture Vendor must submit in writing any deviations to above specifications prior to proceeding.
5. Furniture Vendor is responsible for verifying all quantities based on Gensler furniture plan(s) per issue date above.
6. All furniture must be tagged with room number locations.
7. Furniture vendor is responsible for confirming all item/model numbers per Gensler specifications.
8. Submit (1) finish sample for each specified item to Gensler for approval prior to fabrication.
9. Furniture Vendor shall certify that all products meet all regulations of the jurisdiction in which the project is located and includes required stamps, certification and labeling to meet local code requirements.
10. Fabric to be backed according to manufacturer's recommendations for specified application.
11. Furniture Vendor is responsible for confirming, extending, or establishing fabric reserves in appropriate quantities and to meet project schedule.

Houston, Texas

Gensler

RICE MCNAIR HALL PHASE 1.3 & 1.4

Location: Houston, Texas

Project Number: 002.8270.000

LG05

Created : 12/18/2018

2019/01/29 REVISION 1
2019/01/31 REVISION 2

Product Info

Manufacturer: OFS Furniture

Product Name: Hinchada - Bench/Ottoman

Attributes

Model #: HN-20RD

[DIMENSIONS]

Diameter: 20.75"

Seat Height: 18"

[FINISH]

Upholstery: UP05

Indicative Photo

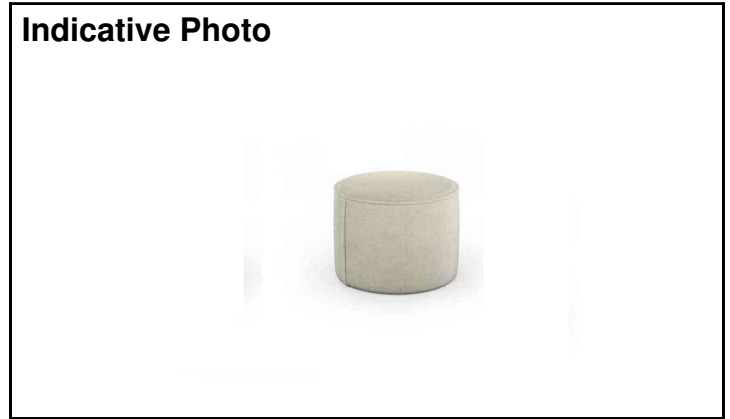

UP05

INFINITY ASTER

by Momentum Textiles

#	Rooms	Quantity
138	Community Commons	4
		Total: 4

REQUIREMENTS

1. Drawings are for reference only. See furniture plan(s) for configurations.
2. Submit drawings for approval prior to proceeding.
3. Furniture Vendor must provide installation drawings for approval prior to proceeding.
4. Furniture Vendor must submit in writing any deviations to above specifications prior to proceeding.
5. Furniture Vendor is responsible for verifying all quantities based on Gensler furniture plan(s) per issue date above.
6. All furniture must be tagged with room number locations.
7. Furniture vendor is responsible for confirming all item/model numbers per Gensler specifications.
8. Submit (1) finish sample for each specified item to Gensler for approval prior to fabrication.
9. Furniture Vendor shall certify that all products meet all regulations of the jurisdiction in which the project is located and includes required stamps, certification and labeling to meet local code requirements.
10. Fabric to be backed according to manufacturer's recommendations for specified application.
11. Furniture Vendor is responsible for confirming, extending, or establishing fabric reserves in appropriate quantities and to meet project schedule.

Houston, Texas

Gensler

RICE MCNAIR HALL PHASE 1.3 & 1.4

Location: Houston, Texas

Project Number: 002.8270.000

TA01

Created : 12/18/2018

2019/01/29 REVISION 1
2019/01/31 REVISION 2

Product Info

Manufacturer: Davis Furniture Industries

Product Name: Techniq

Attributes

Model #: TQ2260

[DIMENSIONS]

Width: 60

Depth: 30

Height: 29

[FINISH]

Top: LAM- Designer White

Base: Chrome

Notes

Rectangle Top with T-Leg Inset Base

#	Rooms	Quantity
120	Multipurpose Room	10
100	Multipurpose Room	10
		Total: 20

Indicative Photo



REQUIREMENTS

1. Drawings are for reference only. See furniture plan(s) for configurations.
2. Submit drawings for approval prior to proceeding.
3. Furniture Vendor must provide installation drawings for approval prior to proceeding.
4. Furniture Vendor must submit in writing any deviations to above specifications prior to proceeding.
5. Furniture Vendor is responsible for verifying all quantities based on Gensler furniture plan(s) per issue date above.
6. All furniture must be tagged with room number locations.
7. Furniture vendor is responsible for confirming all item/model numbers per Gensler specifications.
8. Submit (1) finish sample for each specified item to Gensler for approval prior to fabrication.
9. Furniture Vendor shall certify that all products meet all regulations of the jurisdiction in which the project is located and includes required stamps, certification and labeling to meet local code requirements.
10. Fabric to be backed according to manufacturer's recommendations for specified application.
11. Furniture Vendor is responsible for confirming, extending, or establishing fabric reserves in appropriate quantities and to meet project schedule.

Houston, Texas

Gensler

RICE MCNAIR HALL PHASE 1.3 & 1.4

Location: Houston, Texas

Project Number: 002.8270.000

TA02

Created : 12/18/2018

2019/01/31 REVISION 2

Product Info

Manufacturer: OFS

Product Name: Nineteen20 Table

Model Number: TOP DT-T302-4RDT BASE 5510 / A2K

[DIMENSIONS]

Width: 2'

Depth: 3'

Height: DINING HEIGHT

[FINISH]

Top Material : LAM- DESIGNER WHITE

Base Material: CHROME

Indicative Photo



#	Rooms	Quantity
138	Community Commons	4
		Total: 4

REQUIREMENTS

1. Drawings are for reference only. See furniture plan(s) for configurations.
2. Submit drawings for approval prior to proceeding.
3. Furniture Vendor must provide installation drawings for approval prior to proceeding.
4. Furniture Vendor must submit in writing any deviations to above specifications prior to proceeding.
5. Furniture Vendor is responsible for verifying all quantities based on Gensler furniture plan(s) per issue date above.
6. All furniture must be tagged with room number locations.
7. Furniture vendor is responsible for confirming all item/model numbers per Gensler specifications.
8. Submit (1) finish sample for each specified item to Gensler for approval prior to fabrication.
9. Furniture Vendor shall certify that all products meet all regulations of the jurisdiction in which the project is located and includes required stamps, certification and labeling to meet local code requirements.
10. Fabric to be backed according to manufacturer's recommendations for specified application.
11. Furniture Vendor is responsible for confirming, extending, or establishing fabric reserves in appropriate quantities and to meet project schedule.

Houston, Texas

Gensler

RICE MCNAIR HALL PHASE 1.3 & 1.4

Location: Houston, Texas

Project Number: 002.8270.000

TA03

Created : 12/18/2018

2019/01/31 REVISION 2

Product Info

Manufacturer: KnollStudio

Product Name: Risom Side Table - Round

Attributes

Model #: 614TR

[DIMENSIONS]

Width: 18"

Depth: 18"

Height: 20"

[FINISH]

Top: Light Walnut

Indicative Photo



#	Rooms	Quantity
138	Community Commons	3
		Total: 3

REQUIREMENTS

1. Drawings are for reference only. See furniture plan(s) for configurations.
2. Submit drawings for approval prior to proceeding.
3. Furniture Vendor must provide installation drawings for approval prior to proceeding.
4. Furniture Vendor must submit in writing any deviations to above specifications prior to proceeding.
5. Furniture Vendor is responsible for verifying all quantities based on Gensler furniture plan(s) per issue date above.
6. All furniture must be tagged with room number locations.
7. Furniture vendor is responsible for confirming all item/model numbers per Gensler specifications.
8. Submit (1) finish sample for each specified item to Gensler for approval prior to fabrication.
9. Furniture Vendor shall certify that all products meet all regulations of the jurisdiction in which the project is located and includes required stamps, certification and labeling to meet local code requirements.
10. Fabric to be backed according to manufacturer's recommendations for specified application.
11. Furniture Vendor is responsible for confirming, extending, or establishing fabric reserves in appropriate quantities and to meet project schedule.

Houston, Texas

Gensler

RICE MCNAIR HALL PHASE 1.3 & 1.4

Location: Houston, Texas

Project Number: 002.8270.000

TA04

Created : 12/18/2018

2019/01/31 REVISION 2

Product Info

Manufacturer: OFS Furniture

Product Name: Bendz

Attributes

Model #: BZ-1914T

[DIMENSIONS]

Width: 19.5"

Depth: 14"

Height: 25.5"

[FINISH]

Top: Walnut

Base: Brushed Stainless Steel

Indicative Photo



#	Rooms	Quantity
138	Community Commons	4
		Total: 4

REQUIREMENTS

1. Drawings are for reference only. See furniture plan(s) for configurations.
2. Submit drawings for approval prior to proceeding.
3. Furniture Vendor must provide installation drawings for approval prior to proceeding.
4. Furniture Vendor must submit in writing any deviations to above specifications prior to proceeding.
5. Furniture Vendor is responsible for verifying all quantities based on Gensler furniture plan(s) per issue date above.
6. All furniture must be tagged with room number locations.
7. Furniture vendor is responsible for confirming all item/model numbers per Gensler specifications.
8. Submit (1) finish sample for each specified item to Gensler for approval prior to fabrication.
9. Furniture Vendor shall certify that all products meet all regulations of the jurisdiction in which the project is located and includes required stamps, certification and labeling to meet local code requirements.
10. Fabric to be backed according to manufacturer's recommendations for specified application.
11. Furniture Vendor is responsible for confirming, extending, or establishing fabric reserves in appropriate quantities and to meet project schedule.

Houston, Texas

Gensler

RICE MCNAIR HALL PHASE 1.3 & 1.4

Location: Houston, Texas

Project Number: 002.8270.000

TA05

Created : 12/18/2018

2019/01/31 REVISION 2

Product Info

Manufacturer: Davis Furniture Industries

Product Name: Prat

Attributes

Model #: CUSTOM 7' TABLE MADE BY DAVIS FURNITURE.

[DIMENSIONS]

Width: 7'

Depth: 3' 6"

Height: 42"

[FINISH]

Top Material : WALNUT ON ASH

Top Finish:

Indicative Photo



#	Rooms	Quantity
138	Community Commons	2
		Total: 2

NOTES: ANCHOR FURNITURE TO FLOOR.

REQUIREMENTS

1. Drawings are for reference only. See furniture plan(s) for configurations.
2. Submit drawings for approval prior to proceeding.
3. Furniture Vendor must provide installation drawings for approval prior to proceeding.
4. Furniture Vendor must submit in writing any deviations to above specifications prior to proceeding.
5. Furniture Vendor is responsible for verifying all quantities based on Gensler furniture plan(s) per issue date above.
6. All furniture must be tagged with room number locations.
7. Furniture vendor is responsible for confirming all item/model numbers per Gensler specifications.
8. Submit (1) finish sample for each specified item to Gensler for approval prior to fabrication.
9. Furniture Vendor shall certify that all products meet all regulations of the jurisdiction in which the project is located and includes required stamps, certification and labeling to meet local code requirements.
10. Fabric to be backed according to manufacturer's recommendations for specified application.
11. Furniture Vendor is responsible for confirming, extending, or establishing fabric reserves in appropriate quantities and to meet project schedule.

Houston, Texas

Gensler

RICE MCNAIR HALL PHASE 1.3 & 1.4

Location: Houston, Texas

Project Number: 002.8270.000

TA06

Created : 12/18/2018

2019/01/31 REVISION 2

Product Info

Manufacturer: Herman Miller

Product Name: Eames Tables

Attributes

Model #: ET-87V-S-__-CR

[DIMENSIONS]

Width: 60"

Depth: 30"

Height: 28.5"

[FINISH]

Top: HM WALNUT ON ASH EV

Base: chrome

Notes

HUDDLE ROOMS

Indicative Photo

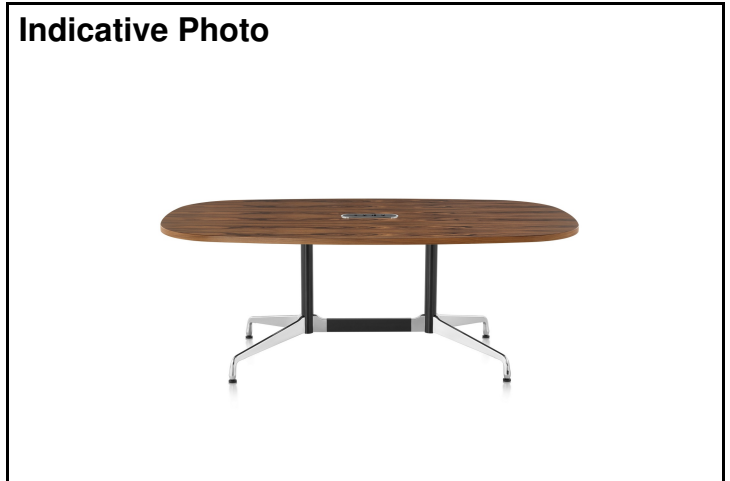

REQUIREMENTS

1. Drawings are for reference only. See furniture plan(s) for configurations.
2. Submit drawings for approval prior to proceeding.
3. Furniture Vendor must provide installation drawings for approval prior to proceeding.
4. Furniture Vendor must submit in writing any deviations to above specifications prior to proceeding.
5. Furniture Vendor is responsible for verifying all quantities based on Gensler furniture plan(s) per issue date above.
6. All furniture must be tagged with room number locations.
7. Furniture vendor is responsible for confirming all item/model numbers per Gensler specifications.
8. Submit (1) finish sample for each specified item to Gensler for approval prior to fabrication.
9. Furniture Vendor shall certify that all products meet all regulations of the jurisdiction in which the project is located and includes required stamps, certification and labeling to meet local code requirements.
10. Fabric to be backed according to manufacturer's recommendations for specified application.
11. Furniture Vendor is responsible for confirming, extending, or establishing fabric reserves in appropriate quantities and to meet project schedule.

Houston, Texas

Gensler

RICE MCNAIR HALL PHASE 1.3 & 1.4

Location: Houston, Texas

Project Number: 002.8270.000

TA07

Created : 12/18/2018

2019/01/31 REVISION 2

Product Info

Manufacturer: GEIGER

Product Name: Caucus

Attributes

Model #: AP4PP-4896

[DIMENSIONS]

Width: 8'

Depth: 4'

Height: 29"

[FINISH]

Top: HM WALNUT ON ASH EV

Base:

Indicative Photo



#	Rooms	Quantity
95	Conference Room	1
		Total: 1

REQUIREMENTS

1. Drawings are for reference only. See furniture plan(s) for configurations.
2. Submit drawings for approval prior to proceeding.
3. Furniture Vendor must provide installation drawings for approval prior to proceeding.
4. Furniture Vendor must submit in writing any deviations to above specifications prior to proceeding.
5. Furniture Vendor is responsible for verifying all quantities based on Gensler furniture plan(s) per issue date above.
6. All furniture must be tagged with room number locations.
7. Furniture vendor is responsible for confirming all item/model numbers per Gensler specifications.
8. Submit (1) finish sample for each specified item to Gensler for approval prior to fabrication.
9. Furniture Vendor shall certify that all products meet all regulations of the jurisdiction in which the project is located and includes required stamps, certification and labeling to meet local code requirements.
10. Fabric to be backed according to manufacturer's recommendations for specified application.
11. Furniture Vendor is responsible for confirming, extending, or establishing fabric reserves in appropriate quantities and to meet project schedule.

Houston, Texas

Gensler

RICE MCNAIR HALL PHASE 1.3 & 1.4

Location: Houston, Texas

Project Number: 002.8270.000

TA10

Created : 12/18/2018

2019/01/31 REVISION 2

Product Info

Manufacturer: GEIGER

Product Name: Metal Series

Attributes

Model #: AMS4A-30

[DIMENSIONS]

Width: 2'-6"

Height: 20"

[FINISH]

Top: GLASS

Frame: POLISHED
ALUMINUM

Indicative Photo



#	Rooms	Quantity
138	COMMUNITY COMMONS	2

REQUIREMENTS

1. Drawings are for reference only. See furniture plan(s) for configurations.
2. Submit drawings for approval prior to proceeding.
3. Furniture Vendor must provide installation drawings for approval prior to proceeding.
4. Furniture Vendor must submit in writing any deviations to above specifications prior to proceeding.
5. Furniture Vendor is responsible for verifying all quantities based on Gensler furniture plan(s) per issue date above.
6. All furniture must be tagged with room number locations.
7. Furniture vendor is responsible for confirming all item/model numbers per Gensler specifications.
8. Submit (1) finish sample for each specified item to Gensler for approval prior to fabrication.
9. Furniture Vendor shall certify that all products meet all regulations of the jurisdiction in which the project is located and includes required stamps, certification and labeling to meet local code requirements.
10. Fabric to be backed according to manufacturer's recommendations for specified application.
11. Furniture Vendor is responsible for confirming, extending, or establishing fabric reserves in appropriate quantities and to meet project schedule.

Houston, Texas

Gensler