

Moveable Furnishings Specification

Project Name Rice University MD Anderson Biology Building	Date	08.15.19
	Item	Chair
	Item Tag	CH-01

Product	
Manufacturer / Product	Allsteel, Herman Miller or Knoll Ergonomic Task Chair
Product No.	
Description	Ergonomic Task Chair Standard Height Fully Adjustable Arms Hard Floor or Carpet Casters
Quantity:	43
Location:	Room B06A, 101A, 101B, 101C, 101D, 102A, 102B, 102C, 103A, 103B, 103C, 103D, 103E, 104A, 104B, 104C, 104D, 106, 107, 109, 120, 212, 213, 272, 349, 351, 355, 357, 371, 372



Finish	
Description	Frame/Base Finish
Color	G1 Graphite



Finish	
Description	Upholstery
Manufacturer	
Grade	Grade 2
Color	Rhythm, Black

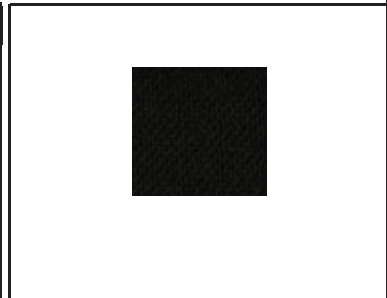

NOTES: Allsteel, Herman Miller or Knoll Products, No Substitutions
Respondent to specify manufacture and product number

Moveable Furnishings Specification

Project Name **Rice University**
 MD Anderson Biology Building

Date 08.15.19

Item Chair

Item Tag **CH-02**

Product

Manufacturer / HAY
 Product

Product No. AAC1704
 Description About A Chair
 4-Leg Base
 Armless
 Fully Upholstered
 Standard Glides

Quantity: 73

Location: **Room 101A, 101B, 101C, 101D, 102A, 102B, 102C, 103A, 103B, 103C, 103D, 103E, 104A, 104C, 104D, 106, 107, 109, 120, 212, 213, 215, 217, 219, 221, 252, 253, 255, 259, 260, 265, 267, 272, 349, 351, 355, 357, 371, 372**



Finish

Description Base Finish
 Color Chromed Steel



Finish

Description Upholstery
 Manufacturer Kvadrat
 Grade Grade 2
 Color Steelcut Trio

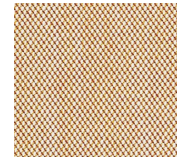

NOTES:

No substitution
 Mike Denney, mike@mdi.design, 713.871.9009

Moveable Furnishings Specification

Project Name **Rice University**
 MD Anderson Biology Building

Date 08.15.19

Item Chair

Item Tag **CH-03**

Product

Manufacturer / Sit On It
 Product

Product No. 2722YA142B1FC1B17~C17S0MC7FABRIC~FG1~KD

Description Amplify Midback Task Chair
 Mesh Back
 Enhanced Synchro Control
 Height/Width Adjustable Arms
 Hard Floor and Carpet Casters

Quantity: 107

Location: **Room 211, 216, 218, 220, 222, 223, 224, 225, 251, 254, 269 273, 353, 354, 358, 359, 360, 361, 362, 363, 364, 365, 366, 368, 369**



Finish

Description Frame/Base Finish

Color Black



Finish

Description Mesh Back Finish

Color Fog



Finish

Description Upholstery

Manufacturer Sit On It

Grade Grade 1

Color Spice, Peppercorn



NOTES:

No Substitution
 Clare Devlin, CDevlin@exemplis.com, 7832-570-3001

Moveable Furnishings Specification

Project Name	Rice University	Date	08.15.19
	MD Anderson Biology Building	Item	Chair
		Item Tag	CH-03 ALT

Product	
Manufacturer / Product	Herman Miller
Product No.	<i>CJ123AAHCAJG1C7G1BK3SL15</i>
Description	Celle Work Chair Standard Height Adjustable Lumbar Support Hard Floors or Carpet Casters
Quantity:	107
Location:	Room 211, 216, 218, 220, 222, 223, 224, 225, 251, 254, 269, 273, 353, 354, 358, 359, 360, 361, 362, 363, 364, 365, 366, 368, 369



Finish	
Description	Base/Frame Finish
Color	G1 Graphite





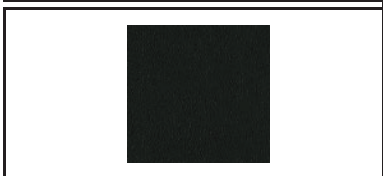

Finish	
Description	Back Finish
Color	BK Black

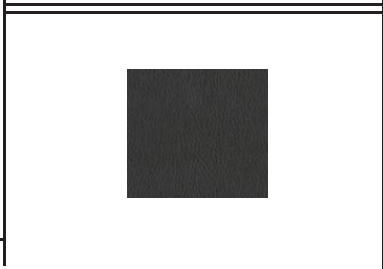

Finish	
Description	Fabric
Manufacturer	Herman Miller
Grade	Grade 2
Color	Sequel Carbon, Dark



NOTES: Rebekah Kieval, Rebekah_Kieval@hermanmiller.com, 713-296-9481
No Substitution

Moveable Furnishings Specification	
Project Name Rice University MD Anderson Biology Building	Date 08.15.19 Item Chair Item Tag CH-04
Product Manufacturer / Product Herman Miller or Similar Product No. <i>WC410NMSG1U5SY</i> Description Caper Stacking Chair Molded Seat No Arms Soft wheel caster, carpet or hard floors Quantity: 32 Location: Registrar Controlled Classroom	
Finish Description Frame/Base Finish Color MS Metallic Silver	
Finish Description Seat/Back Finish Color Graphite	
Finish Description Arm Cap Finish Color Silver Grey	
NOTES: No Substitutions Rebekah Kieval, Rebekah_Kieval@hermanmiller.com, 713-296-9481	

Moveable Furnishings Specification

Project Name **Rice University**
 MD Anderson Biology Building

Date 08.15.19

Item Chair

Item Tag **CH-05A**

Product

Manufacturer / Product Herman Miller or Similar
 Product No. *WC510LMSG1YXSYLBA*
 Description Caper Stacking Chair
 Tablet Arm Right
 Molded seat
 Floor saver glide insert, hard floors only

Quantity: 18

Location: **Registrar Controlled Classroom**



Finish

Description Frame/Base Finish
 Color MS Metallic Silver



Finish

Description Seat/Back Finish
 Color G1 Graphite



Finish

Description Arm Cap Finish
 Color SY Silver Grey



Finish

Description Tablet Arm Finish
 Color LBA Clear on Ash

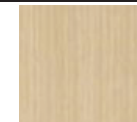

NOTES:

No Substitutions
 Rebekah Kieval, Rebekah_Kieval@hermanmiller.com, 713-296-9481

Moveable Furnishings Specification

Project Name **Rice University**
 MD Anderson Biology Building

Date 08.15.19

Item Chair

Item Tag **CH-05B**

Product

Manufacturer / Product Herman Miller or Similar
 Product No. *WC510LMSG1YXSYLBA*
 Description Caper Stacking Chair
 Tablet Arm Left
 Molded seat
 Floor saver glide insert, hard floors only

Quantity: 3

Location: **Registrar Controlled Classroom**

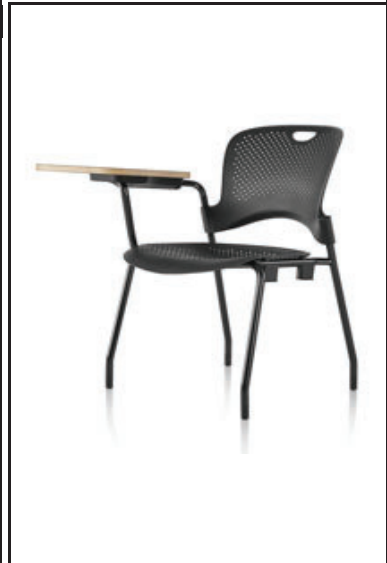

Finish

Description Frame/Base Finish
 Color MS Metallic Silver



Finish

Description Seat/Back Finish
 Color G1 Graphite



Finish

Description Arm Cap Finish
 Color SY Silver Grey



Finish

Description Tablet Arm Finish
 Color LBA Clear on Ash



NOTES: No Substitutions
 Rebekah Kieval, Rebekah_Kieval@hermanmiller.com, 713-296-9481

Moveable Furnishings Specification

Project Name **Rice University**
 MD Anderson Biology Building

Date 08.15.19

Item Chair

Item Tag **CH-06**

Product

Manufacturer / HAY
 Product

Product No. AAC1601BLKBPSSDG

Description About A Chair
 4-Leg Base
 Armless w/ Optional Seat Upholstery
 Polypropylene shell
 Non-upholstered
 Glides

Standard

Quantity: 32

Location: **Room 233, 333**



Finish

Description Seat Finish

Color Black



Finish

Description Base Finish

Color Black Powder Coated Steel



NOTES:

No Substitution
 Madeline Rains, mrains@dwr.com, 972-689-7459

Moveable Furnishings Specification

Project Name **Rice University**
 MD Anderson Biology Building

Date 08.15.19

Item Chair

Item Tag **CH-07**

Product

Manufacturer / HAY
 Product

Product No. *AAS38H01BLKBPSSDG*

Description About A Stool
 Metal Base
 High Height w/ Optional Front Upholstery
 Polypropylene shell,
 Non-upholstered
 Standard Glides

Quantity: 8

Location: **Room 233, 333**



Finish

Description Seat Finish

Color Black



Finish

Description Base Finish

Color Black Powder Coated Steel



NOTES:

No Substitution
 Madeline Rains, mrains@dwr.com, 972-689-7459

Moveable Furnishings Specification

Project Name **Rice University**
 MD Anderson Biology Building

Date 08.15.19

Item Chair

Item Tag **CH-08**

Product

Manufacturer / Sit On It
 Product

Product No. 1033BK1FAR4AL1LA2~CH1FC1B17CS6MC21FABRIC~KD

Description Novo Midback Task Chair
 Mesh Back
 Standard Synchro
 Height Adjustable Arms
 Hard Floor or Carpet Casters

Quantity: 94

Location: Room 100, 105, 228, 229, 235, 328, 329, 335



Finish

Description Seat Finish

Color Black



Finish

Description Mesh Back Finish

Color Nickel

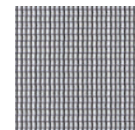

Finish

Description Upholstery

Manufacturer Sit On It

Grade Grade 1

Color Spice, Carraway



NOTES:

No Substitution
 Clare Devlin, CDevlin@exemplis.com, 832-570-3001

Moveable Furnishings Specification

Project Name **Rice University**
 MD Anderson Biology Building

Date 08.15.19

Item Chair

Item Tag **CH-09**

Product

Manufacturer / Sit On It
 Product

Product No. *1033BK1BS1AR4AL1LA1FC1B17CS6MC20FABRIC~FG1KD*

Description Novo Midback Stool
 Mesh Back
 Height Adjustable Arms
 Hard Floor or Carpet Casters

Quantity: 1

Location: **Registrar Controlled Classroom**



Finish

Description Seat Finish

Color Black



Finish

Description Mesh Back Finish

Color Onyx

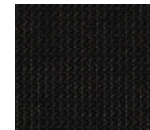

Finish

Description Upholstery

Manufacturer Sit On It

Grade Grade 1

Color Spice, Carraway



NOTES

No Substitutions
 Clare Devlin, CDevlin@exemplis.com, 832-570-3001

Moveable Furnishings Specification

Project Name	Rice University	Date	08.15.19
	MD Anderson Biology Building	Item	Stool
		Item Tag	CH-10

Product	
Manufacturer / Product	Cramer
Product No.	<i>RPMD7</i>
Description	Rhino Plus Stool Desk to Counter Height No Arms Glides
Quantity:	142
Location:	Room B07, B09A, 123,123A,124A, 210A, 210, 210D, 210J, 230B, 230D, 230E, 250, 250A, 250B, 250C, 270, 270B, 321, 330, 330E, 330L, 370, 370D, 370E, 370F 370K, 370L



Finish	
Description	Upholstery
Manufacturer	Cramer
Grade	Grade 2
Color	Rally Black Vinyl



NOTES: No Substitution
 Scott Lowe, scottlowe@the-lowegroup.com, 281-255-4449

Moveable Furnishings Specification

Project Name **Rice University**
 MD Anderson Biology Building

Date 08.15.19

Item Credenza

Item Tag **CR-01**

Product

Manufacturer / OFS
 Product
 Product No. *CCM7136BCCCO2EYGRIP*
 Description 71x20x36 Intermix Credenza
 Buffet Door/Drawer

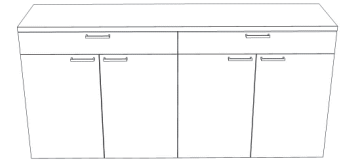

Quantity: 2
 Location: **Room 100, 105**

Finish

Description Finish
 Color Linen CO2



Finish

Description Forte Pull Finish
 Color Silver

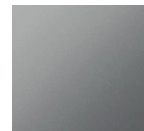

NOTES: No Substitution
 Mike Denney, mike@mdi.design, 713-871-9009

Moveable Furnishings Specification

Project Name **Rice University**
MD Anderson Biology Building

Date 08.15.19

Item Lounge

Item Tag **L-01**

Product

Manufacturer / Nemschoff
Product

Product No. *Recliner*

Description Leonard II Recliner
Highback
Pneumatic control

Quantity: 1

Location: **Room 126**



Finish

Description Upholstery
Manufacturer Maharam
Color Lariat 44040-016 Pebble

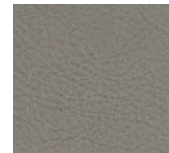

NOTES: Lynn Windus, lynn_windus@nemschoff.com, 281-326-4587
No Substitution

Moveable Furnishings Specification

Project Name **Rice University**
 MD Anderson Biology Building

Date 08.15.19

Item Lounge

Item Tag **L-02**

Product

Manufacturer / Keilhauer
 Product
 Product No. 74220
 Description Keilhauer Danber Sofa
 Extended Two Seat
 Ash Legs

Quantity: 4

Location: **Room 100A, 214, 264, 367**



Finish

Description Ash Wood Base Finish

Color Fog AHF



Finish

Description Upholstery

Manufacturer Maharam

Color Manner 466177-026 Basin



NOTES:

No Substituiton
 Shari Beard, shari@suegormanlp.com, 281-415-8771

Moveable Furnishings Specification

Project Name **Rice University**
MD Anderson Biology Building

Date 08.15.19

Item Lounge

Item Tag **L-03**

Product

Manufacturer / Product Bernhardt

Product No. 5682

Description Bernhardt Diego Lounge with Handle
Weight Activated Self-Locking Casters

Quantity: 2

Location: **Room 128**



Finish

Description Upholstery

Manufacturer Bernhardt

Color Vivid Grass 3523-030



NOTES:

No Substitution
Ana Davidson, ana@davidsonrice.com, 832-660-8964

Moveable Furnishings Specification

Project Name **Rice University**
MD Anderson Biology Building

Date 08.15.19

Item Lounge

Item Tag **L-04**

Product

Manufacturer / OFS
Product

Product No. *F81016*

Description Mention Midback
Fully Upholstered
Return to Center swivel column on four prong base

Quantity: 8

Location: **Room 100A, 214, 264, 367**



Finish

Description Upholstery

Manufacturer Momentum

Grade Grade 6

Color Free Oasis

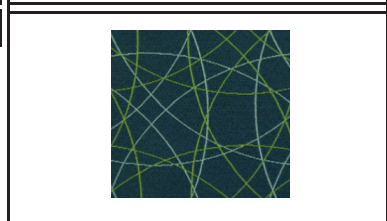

NOTES:

No Substitution
Mike Denney, mike@mdi.design, 713-871-9009

Moveable Furnishings Specification

Project Name **Rice University**
 MD Anderson Biology Building

Date 08.15.19

Item Markerboard

Item Tag **MB-01**

Product

Manufacturer / Claridge
 Product

Product No.

Description InvisiMount Profile Series LCS Boards
 Z-cleat Hangers
 5'W x 4'H

Quantity: 43

Location: Room B06A, 100A, 101A, 101B, 101C, 101D, 102A, 102B, 102C, 103A, 103B,
 103C, 103D, 103E, 104A, 104B, 104C, 104D, 106, 107, 109, 120, 212, 213, 215,
 217, 219, 221, 252, 253, 255, 257, 259, 261, 264, 265, 267, 272, 349, 351, 355,
 357, 367, 371, 372

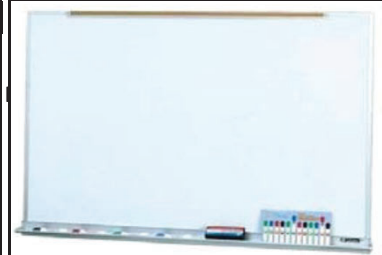

Finish

Description Finish

Color White



NOTES:

No substitution
 Jeff Lewis, jeff@lewisgroup.com, 713-206-6228

Moveable Furnishings Specification

Project Name **Rice University**
 MD Anderson Biology Building

Date 08.15.19
 Item Markerboard
 Item Tag **MB-01 ALT**

Product

Manufacturer / Claridge
 Product
 Product No. *CMGMI45*
 Description InvisiMount Magnetic Glassboard
 48 x 60
 ¼" Clear Tempered Dry erase surface
 Steel backing
 (4) Rare Earth Magents
 Slim Marker Caddy Tray



Quantity: 43
 Location: **Room B06A, 100A, 101A, 101B, 101C, 101D, 102A, 102B, 102C, 103A, 103B, 103C, 103D, 103E, 104A, 104B, 104C, 104D, 106, 107, 109, 120, 212, 213, 215, 217, 219, 221, 252, 253, 255, 257, 259, 261, 264, 265, 267, 272, 349, 351, 355, 357, 367, 371, 372**

Finish

Description Finish
 Color White



NOTES: No substitution
 Jeff Lewis, jeff@lewisgroup.com, 713-206-6228

Moveable Furnishings Specification

Project Name **Rice University**
 MD Anderson Biology Building

Date 08.15.19

Item Table

Item Tag **PO-1**

Product

Manufacturer / Product Alsteel, Herman Miller or Knoll

Product No. *Private Office*

Description

- 30D x 60W Rectangular Table, laminate, sit-to-stand, C-foot
- 30W x 15H Overhead Storage Cabinet, hinged doors, wall mount, laminate case/doors
- 30W x 24H Tackboard, tackable fabric, cable managers (set of 12)
- 30D Closed Support Leg
- 30W Task light
- 30W x 15D x 64H bookcase, textured paint on smooth steel
- 30W Lateral file
- 28D B/B/F pedestal, textured paint on smooth steel, drawer divider in one box drawer, pencil tray in one box drawer, 2 file converters in each drawer, bar pull
- 28D F/F pedestal, textured paint on smooth steel, 2 file converters in each drawer, bar pull
- 30Wx 20D 2-drawer lateral file, textured paint on smooth steel, front-to-back filing, bar pull
- Logic Mini – 1 receptacle, 2 powered USB, 6' cord, surface clamp

Quantity:

24

Location:

Room 102B, 102C, 103A, 103B, 103C, 103D, 212, 213, 215, 217, 219, 221, 252, 253, 255, 257, 265, 267,272, 273 351, 371, 372

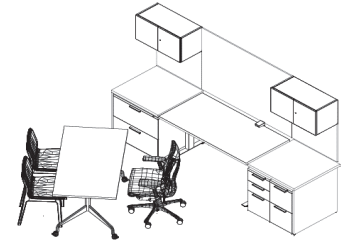

Finish

Description Worksurface/Closed Support Leg/Overhead Storage/Rectangular Table Finish

Color LBC Walnut on Ash



Finish

Description Worksurface Base/Support Leg/Bookcase/Pedestal/Lateral File/Logic Mini Finish

Color 91 White

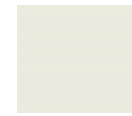

Finish

Description Pull Finish

Color MS Metallic Silver



Finish

Description Tackboard Fabric

Manufacturer Grade 2

Grade Cord, White Ash

Color



NOTES: Allsteel, Herman Miller or Knoll, No Substitutions
 Respondent to specify manufacture and product number

Moveable Furnishings Specification

Project Name **Rice University**
 MD Anderson Biology Building

Date 08.15.19

Item Table

Item Tag **PO-1A**

Product

Manufacturer / Product Allsteel, Herman Miller or Knoll

Product No. *Private Office*
 Description

30D x 54W Rectangular Table, laminate, sit-to-stand, C-foot
 30W x 15H Overhead Storage Cabinet, hinged doors, wall mount, laminate case/doors
 30W x 24H Tackboard, tackable fabric, cable managers (set of 12)
 30D Closed Support Leg
 30W Task light
 30W x 15D x 64H bookcase, textured paint on smooth steel
 30W Lateral file
 28D B/B/F pedestal, textured paint on smooth steel, drawer divider in one box drawer, pencil tray in one box drawer, 2 file converters in each drawer, bar pull
 28D F/F pedestal, textured paint on smooth steel, 2 file converters in each drawer, bar pull
 30W x 20D 2-drawer lateral file, textured paint on smooth steel, front-to-back filing, bar pull
 Logic Mini – 1 receptacle, 2 powered USB, 6' cord, surface clamp

Quantity: 1
 Location: **Room 349**



Finish

Description Worksurface/Closed Support Leg/Overhead Storage/Rectangular Table Finish
 Color LBC Walnut on Ash



Finish

Description Worksurface Base/Support Leg/Bookcase/Pedestal/Lateral File/Logic Mini Finish
 Color 91 White

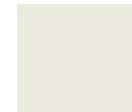

Finish

Description Pull Finish
 Color MS Metallic Silver



Finish

Description Tackboard Fabric
 Manufacturer Grade 2
 Grade Cord, White Ash
 Color



NOTES: Allsteel, Herman Miller or Knoll, No Substitutions
 Respondent to specify manufacture and product number

Moveable Furnishings Specification

Project Name **Rice University**
 MD Anderson Biology Building

Date 08.15.19

Item Table

Item Tag **PO-2**

Product

Manufacturer / Product Allsteel, Herman Miller or Knoll

Product No. *Private Office*

Description 30D x 66W Rectangular Table, laminate, sit-to-stand, C-foot, Legs with cross beam
 30W x 15H Overhead Storage Cabinet, hinged doors, wall mount, laminate case/doors
 60W x 24H Tackboard, tackable fabric, cable managers (set of 12)
 60W Modesty Panel, laminate
 30D Closed Support Leg
 30W Task light
 30W x 15D x 64H bookcase, textured paint on smooth steel
 30W Lateral file
 24D B/B/F pedestal, textured paint on smooth steel, drawer divider in one box drawer, 2 file converters in each drawer, bar pull
 24D F/F pedestal, textured paint on smooth steel, 2 file converters in each drawer, bar pull
 30W x 20D 2-drawer lateral file, textured paint on smooth steel, front-to-back filing, bar pull
 Logic Mini – 1 receptacle, 2 powered USB, 6' cord, surface clamp
 6' Power plug strip – 6 AC outlets

Quantity: 8

Location: **Room 101A, 101B, 101C, 101D, 102A, 104B, 120**

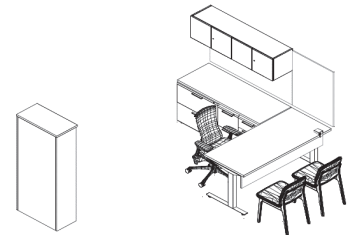

Finish

Description Worksurface/Closed Support Leg/Overhead Storage/Rectangular Table Finish
 Color LBA Clear on Ash

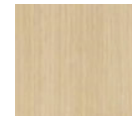

Finish

Description Worksurface Base/Support Leg/Bookcase/Pedestal/Lateral File/Logic Mini Finish
 Color 91 White



Finish

Description Pull Finish
 Color MS Metallic Silver



Finish

Description Tackboard Fabric
 Manufacturer Grade 2
 Grade Cord, White Ash
 Color



NOTES:

Allsteel, Herman Miller or Knoll, No Substitutions
 Respondent to specify manufacture and product number

Moveable Furnishings Specification

Project Name **Rice University**
 MD Anderson Biology Building

Date 08.15.19

Item Table

Item Tag **PO-2A**

Product

Manufacturer / Product Allsteel, Herman Miller or Knoll

Product No. *Private Office*

Description

- 30 Dia Round Table, laminate, single-column base, casters
- 30D x 60W Rectangular Table, laminate, sit-to-stand, C-foot, Legs with cross beam
- 30W x 15H Overhead Storage Cabinet, hinged doors, wall mount, laminate case/doors
- 30W x 39H Tackboard (2)
- 60W Modesty Panel, laminate
- 30D Closed Support Leg
- 30W Task light
- 30W x 15D x 64H bookcase, textured paint on smooth steel
- 30W Lateral file
- 28D B/B/F pedestal, textured paint on smooth steel, drawer divider in one box drawer, pencil tray in one box drawer, 2 file converters in each drawer, bar pull
- 28D F/F pedestal, textured paint on smooth steel, 2 file converters in each drawer, bar pull
- 30W x 20D 2-drawer lateral file, textured paint on smooth steel, front-to-back filing, bar pull
- Logic Mini – 1 receptacle, 2 powered USB, 6’ cord, surface clamp
- 6’ Power plug strip – 6 AC outlets

Quantity:

Location: 7

Room 104A, 104C, 104D, 106, 107, 259, 261

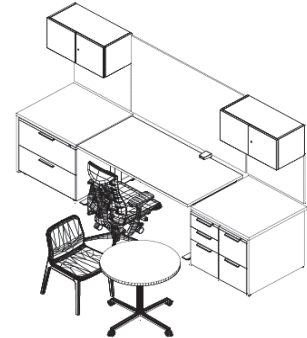

Finish

Description Round Table/Closed Support Leg/Overhead Storage/Rectangular Table Finish

Color LBA Clear on Ash

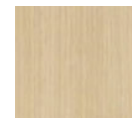

Finish

Description Round Table Base/Support Leg/Bookcase/Pedestal/Lateral File/Logic Mini Finish

Color 91 White

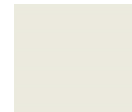

Finish

Description Pull Finish

Color MS Metallic Silver



Finish

Description Tackboard Fabric

Manufacturer Grade 2

Grade Cord, White Ash

Color



NOTES:

Allsteel, Herman Miller or Knoll, No Substitutions
 Respondent to specify manufacture and product number

Moveable Furnishings Specification

Project Name **Rice University**
 MD Anderson Biology Building

Date 08.15.19

Item Table

Item Tag **PO-3**

Product

Manufacturer / Product Allsteel, Herman Miller or Knoll

Product No. *Private Office*

Description

- 36 Dia Round Table, laminate, contract base, casters
- 30D x 60W Rectangular Table, laminate, sit-to-stand, C-foot, Legs with cross beam
- 30D x 30W Rectangular Surface, fixed height, laminate
- 30W x 15H Overhead Storage Cabinet, hinged doors, wall mount, laminate case/doors
- 24H x 30W Tackboard, tackable fabric
- 39H x 60W Tackboard
- 30D Closed Support Leg
- 30W Task light
- 30W x 15D x 64H bookcase, textured paint on smooth steel
- 30W Lateral file
- 28D B/B/F pedestal, textured paint on smooth steel, drawer divider in one box drawer, pencil tray in one box drawer, 2 file converters in each drawer, bar pull
- 28D F/F pedestal, textured paint on smooth steel, 2 file converters in each drawer, bar pull
- 30W x 20D 2-drawer lateral file, textured paint on smooth steel, front-to-back filing, bar pull
- Logic Mini – 1 receptacle, 2 powered USB, 6’ cord, surface clamp
- 6’ Power plug strip – 6 AC outlets

Quantity:

Location: 1

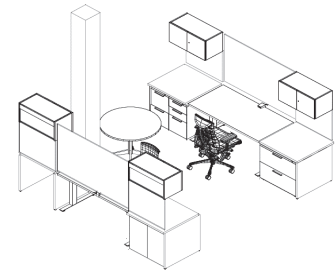

Finish

Description Round Table/Closed Support Leg/Overhead Storage/Rectangular Table Finish

Color LBA Clear on Ash

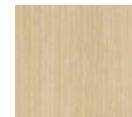

Finish

Description Round Table Base/Support Leg/Bookcase/Pedestal/Lateral File/Logic Mini Finish

Color 91 White

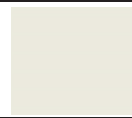

Finish

Description Pull Finish

Color MS Metallic Silver



Finish

Description Tackboard Fabric

Manufacturer Grade 2

Grade Cord, White Ash

Color



NOTES: Allsteel, Herman Miller or Knoll, No Substitutions
 Respondent to specify manufacture and product number

Moveable Furnishings Specification

Project Name **Rice University**
 MD Anderson Biology Building

Date 08.15.19

Item Table

Item Tag **PO-4**

Product

Manufacturer / Product Herman Miller or Similar
 Product No. *Canvas Private Office*
 Description 30D x 60W Peninsula Surface, Rectangular end, laminate, no brackets
 24D Closed Support Leg
 33 7/8W Stiffener
 60W Modesty Panel, laminate
 20D B/B/F Pedestal, textured paint on smooth steel, drawer divider in one box drawer, pencil tray in one box drawer, 2 file converters in each drawer, bar pull

Quantity: 1
 Location: **Room B06A**

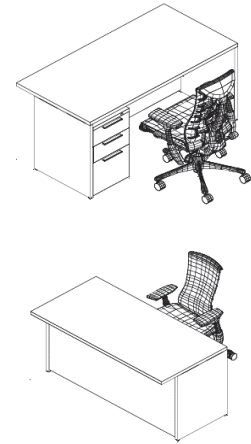

Finish

Description Surface/Closed Support Leg/Modesty Panel Finish
 Color LBA Clear on Ash

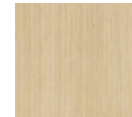

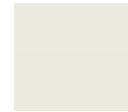

Finish

Description Pedestal/Pull Finish
 Color 91 White

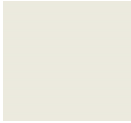

NOTES: Allsteel, Herman Miller or Knoll, No Substitutions
 Respondent to specify manufacture and product number

Moveable Furnishings Specification	
Project Name Rice University MD Anderson Biology Building	Date 08.15.19 Item Table Item Tag T-01
Product	
Manufacturer / Product Allsteel, Herman Miller or Knoll Product No. Description Work Table Laminate Exposed Plywood Edge 16" dia x 25 1/2"H Quantity: 1 Location: Room 126	
Finish	
Description Top Finish Color 91 White	
Finish	
Description Base Finish Color MS Metallic Silver	
NOTES: Allsteel, Herman Miller or Knoll, No Substitutions Respondent to specify manufacture and product number	

Moveable Furnishings Specification

Project Name **Rice University**
 MD Anderson Biology Building

Date 08.15.19

Item Table

Item Tag **T-02**

Product

Manufacturer / Product Herman Miller
 Product No. *U1B75YXS3060LT91NTG*
 Description Everywhere Table 60 x 30
 Rectangular Top Inset Legs
 Casters

Quantity: 16

Location: **Registrar Controlled Classroom**



Finish

Description Top Finish

Color 91 White

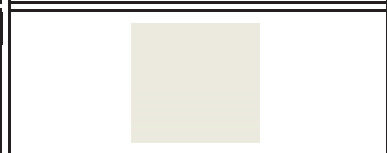

Finish

Description Base Finish

Color MS Metallic Silver



NOTES: No Substitutions
 Rebekah Kieval, Rebekah_Kieval@hermanmiller.com, 713-296-9481

Moveable Furnishings Specification

Project Name	Rice University	Date	08.15.19
	MD Anderson Biology Building	Item	Table
		Item Tag	T-03

Product	
Manufacturer / Product	Allsteel, Herman Miller or Knoll
Product No.	
Description	Square Table Squared Edge, Lam Top 36D x 36W Single Column Base Glides
Quantity:	8
Location:	Room 233, 333



Finish	
Description	Top/Edge Finish
Color	LBA Clear on Ash



Finish	
Description	Base Finish
Color	91 White



NOTES: Allsteel, Herman Miller or Knoll, No Substitutions
Respondent to specify manufacture and product number

Moveable Furnishings Specification

Project Name **Rice University**
 MD Anderson Biology Building

Date 08.15.19

Item Table

Item Tag **T-04**

Product

Manufacturer / Product Allsteel, Herman Miller or Knoll
 Product No.
 Description Flip-Top Rectangular Table Squared Edge
 Laminate Top
 T-Leg inset to sit at end of table
 Glides

Quantity: 18

Location: **Room 235, 335**



Finish

Description Top/Edge Finish

Color LBA Clear on Ash



Finish

Description Base Finish

Color 91 White

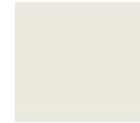

NOTES: Allsteel, Herman Miller or Knoll, No Substitutions
 Respondent to specify manufacture and product number

Moveable Furnishings Specification

Project Name **Rice University**
 MD Anderson Biology Building

Date 08.15.19

Item Table

Item Tag **T-05**

Product

Manufacturer / Surface Tech
 Product

Product No. 1MEDO54X96-LVE

Description Chat Media Table Fixed O Series Laminate Base
 54 x 96" D-Shape Top 12" Base Reverse knife edge
 Flat edge along back Open leg access (2) Grommet cut

Quantity: 2

Location:



Finish

Description Top Finish

Color Formica 7197 Dover White

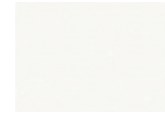

Finish

Description Base Finish

Color Formica 961 Fog



NOTES:

No Substitutions
 Chase Fulbright, chase@fulbrightco.com, 281-357-8288

Moveable Furnishings Specification

Project Name **Rice University**
MD Anderson Biology Building

Date 08.15.19

Item Table

Item Tag **T-06**

Product

Manufacturer / Carolina
Product

Product No. *810-36RD*

Description X & O Table
36" Dia
Tapered Half Cube

Quantity: 4

Location: **Room 100A, 214, 264, 367**



Finish

Description Top/Edge Finish

Color Linen MRO



NOTES:

No Substitutions
Linna Yoon, Linna@mdi.design, 713-871-9009

Moveable Furnishings Specification

Project Name **Rice University**
MD Anderson Biology Building

Date 08.15.19

Item Table

Item Tag **T-07**

Product

Manufacturer / Carolina
Product

Product No. *810-20RD*

Description X & O Table
20" Dia

Quantity: 5

Location: **Room 100A, 128, 214, 264, 367**



Finish

Description Top/Edge Finish

Color Linen MRO



NOTES

No Substitutions
Linna Yoon, Linna@mdi.design, 713-871-9009

Moveable Furnishings Specification

Project Name **Rice University**
 MD Anderson Biology Building

Date 08.15.19

Item Table

Item Tag **T-08**

Product

Manufacturer / OFS
 Product

Product No. *CCP7236RTCO2EYQR*

Description 36 x 72 Intermix Conference Table
 8" Deep Panel Base
 White Power Supply – (2) 15 amp outlets, (2) USB charging ports
 Black Power Supply – (6) 10 am outlets
 24" Wire Manager
 Wire Manager Strip (set of 4) Add two table top cuts

Quantity: 2

Location: **Room 328, 329**

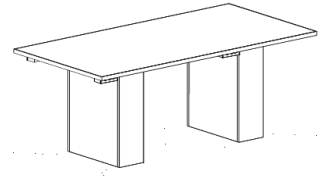

Finish

Description Top/Base Finish

Color Linen CO2



NOTES: No Substitutions
 Linna Yoon, Linna@mdi.design, 713-871-9009

Moveable Furnishings Specification

Project Name **Rice University**
 MD Anderson Biology Building

Date 08.15.19

Item Table

Item Tag **T-09**

Product

Manufacturer / OFS
 Product

Product No. *CCP12048RTCO2EYQR*

Description 48 x 120 Intermix Conference Table
 80 x 33 x 28.75 Panel Pedestal Base for 120" Tops
 White Power Supply – (2) 15 amp outlets, (2) USB charging ports
 Black Power Supply – (6) 10 am outlets
 24" Wire Manager
 Wire Manager Strip (set of 4) Add two table top cuts

Quantity: 2

Location: **Room 100, 105**

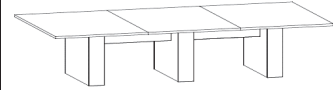

Finish

Description Top/Base Finish

Color Linen CO2



NOTES:

No Substitutions
 Linna Yoon, Linna@mdi.design, 713-871-9009

Moveable Furnishings Specification

Project Name **Rice University**
 MD Anderson Biology Building

Date 08.15.19

Item Table

Item Tag **WS-1**

Product

Manufacturer / Product Allsteel, Herman Miller or Knoll

Product No. *Workstation*

Description 24D 48W Rectangular surface, laminate
 24D Support Panels – left handed and right handed
 12D Support Panel - shared mid-run
 Cable management trough
 48W x 41H Tackable Fabric Tile with 48W tile trim
 68H wall strip, no wall fastener
 48W flip door overhead unit, B-style, lockable
 20D B/B/F Pedestal, textured paint on smooth steel, drawer divider in one box drawer, pencil tray in one box drawer, 2 file converters in each drawer
 6' Power plug strip – 6 AC outlets
 30W Task light

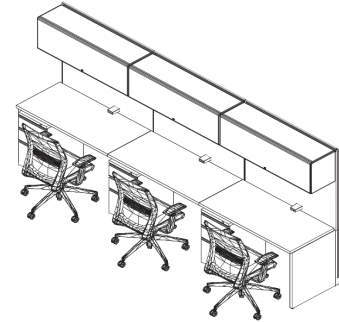

Quantity: 91

Location: **Room 211, 216, 218, 220, 222, 223, 224, 225, 251, 254, 269, 273, 353, 354, 358, 359, 360, 361, 363, 364, 365, 366, 368, 369**

Finish

Description Surface/Support Panel Finish

Color LBA Clear on Ash

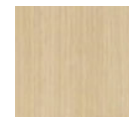

Finish

Description Overhead Unit/Trim/Pedestal/Logic Mini Finish

Color 91 White

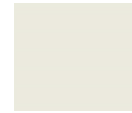

Finish

Description Tackable Fabric Tile Finish

Manufacturer

Grade Grade 2 Cord,

Color White Ash



NOTES: Allsteel, Herman Miller or Knoll, No Substitutions
 Respondent to specify manufacture and product number

Moveable Furnishings Specification

Project Name **Rice University**
 MD Anderson Biology Building

Date 08.15.19

Item Table

Item Tag **WS-2**

Product

Manufacturer / Product Allsteel, Herman Miller or Knoll

Product No. *Workstation*

Description 24D 48W Rectangular surface, laminate
 48W x 68H Frame, base covers, power/data knockouts
 Power entry, 6' long external direct connect
 48W Base power hardness
 15 Amp receptacle 4 circuit duplex, circuit A, 6 per package
 15 Amp receptacle 4 circuit duplex, circuit D, isolated ground, 6 per package
 48W x 63H Tackable fabric tile
 Cable management trough
 24D Support Panels – left handed and right handed
 12D Support Panel – shared mid-run
 48W flip door overhead unit, B-style, lockable
 20D B/B/F Pedestal, textured paint on smooth steel, drawer divider in one box drawer, pencil tray in one box drawer, 2 file converters in each drawer
 6' Power plug strip – 6 AC outlets
 30W Task light
 Logic Mini, 1 receptacle, 2 powered USB, 6' cord, surface clamp

Quantity: 2

Location: **Room 273**

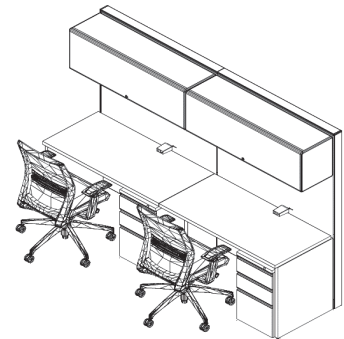

Finish

Description Surface/Support Panel Finish

Color LBA Clear on Ash

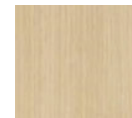

Finish

Description Overhead Unit/Trim/Pedestal/Logic Mini Finish

Color 91 White

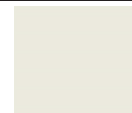

Finish

Description Tackable Fabric Tile Finish

Manufacturer

Grade Grade 2 Cord,

Color White Ash



NOTES: Allsteel, Herman Miller or Knoll, No Substitutions
 Respondent to specify manufacture and product number