



Moveable Furnishings Specification	
Project Name Rice University Brockman Hall for Opera	Date 4/21/2020 Item LV. 1, LV. 1.5 Bench Item Tag B-1
Product	
Manufacturer / Product Martin Bratrud One 630-XA Description Custom Armless/Backless One Collection Bench Approx. 84" Wx33"D x15"H. Metal base and platform. Tight plain seat with center seat delineation Quantity: 11	
Finish	
Description Upholstry Finish: Maharam Color Pace 700011 008 Huron	
Finish	
Description Base Finish: Hand Rubbed Steel Color Oiled Bronze	
NOTES	
Mike Denney, mike@mdi.design, 713.871.9009	

Moveable Furnishings Specification

Project Name	Rice University	Date	4/21/2020
	Brockman Hall for Opera	Item	LV. 2 Bench
		Item Tag	B-2

Product	
Manufacturer / Product	Davis Modo MD-1084
Description	84" Backless Bench Overall 84"W x 17 3/4"D x 18 3/8" H
Quantity:	4



Finish	
Description	Upholstery Finish: Maharan
Color	Pace 700011 008 Huron

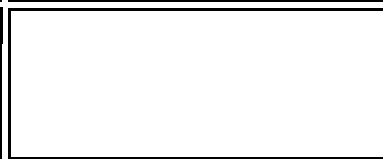

Finish	
Description	Base Finish
Color	Chrome



NOTES
Miriam Jones, 512.587.2298, miriam@jmcassociates.com

Moveable Furnishings Specification

Project Name	Rice University	Date	4/21/2020
	Brockman Hall for Opera	Item	Bookcase
		Item Tag	BC-1

Product	
Manufacturer / Product	Allsteel, Knoll or Herman Miller
Description	Metal bookcase 30"W 38"H, 2 adjustable shelves
Quantity:	5



Finish	
Description	Base Finish
Color	G1 Graphite



NOTES

All other manufacturers products required to be approved as equals

Moveable Furnishings Specification

Project Name	Rice University	Date	4/21/2020
	Brockman Hall for Opera	Item	Bookcase
		Item Tag	BC-2

Product	
Manufacturer / Product	Allsteel, Knoll or Herman Miller
Description	Bookcase 36"W x 51H" x 15"D, Textured paint, adjustable shelves
Quantity:	22



Finish	
Description	Base Finish
Color	G1 Graphite



NOTES Other manufacturers products required to be approved as equals

Moveable Furnishings Specification

Project Name	Rice University	Date	4/21/2020
	Brockman Hall for Opera	Item	Guest Chair
		Item Tag	CH-1

Product	
Manufacturer / Product	Encore Signal 3520 L1 3L-1-E3 PF02 83 POLY
Description	Signal sled base guest chair with black leather arm caps. Felt for wood floors
Quantity:	2



Finish	
Description	Fabric
Color	Geiger Striscia 1AY02 Cheyenne



Finish	
Description	Frame/Base Finish
Color	Metallic Champagne

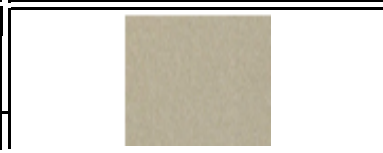

NOTES

Mike Denney T:713.871.9009
Mike@mdi.design

Moveable Furnishings Specification

Project Name	Rice University	Date	4/21/2020
	Brockman Hall for Opera	Item	Guest Chair
		Item Tag	CH-1A

Product	
Manufacturer / Product	Encore Signal
Description	Signal sled base guest chair with black leather arm caps. Felt for wood floors
Quantity:	2



Finish	
Description	Leather
Color	Maharam, color tbd

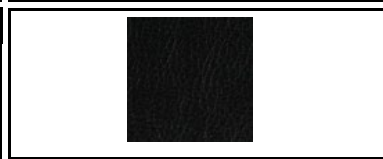

Finish	
Description	Frame/Base Finish
Color	Metallic Champagne

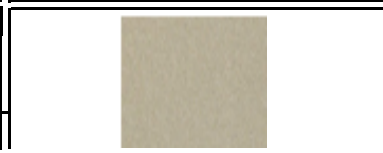

NOTES

Mike Denney T:713.871.9009
Mike@mdi.design

Moveable Furnishings Specification

Project Name	Rice University	Date	4/21/2020
	Brockman Hall for Opera	Item	Guest Chair
		Item Tag	CH-2

Product	
Manufacturer / Product	Geiger Deft SDE2EKNOCAL1AY02
Description	Deft Guest Chair with Arms Uph. Full Back and Seat (Inside & Outside) Ash Frame (1.5 yds / 27 sf)
Quantity:	26



Finish	
Description	Fabric
Color	Geiger, Price Group 8, Striscia 1AY02 Cheyenne



Finish	
Description	Frame/Base Finish
Color	EW Medium Matte Walnut

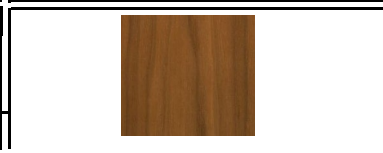

NOTES

Jamie Aragones, jamie_aragones@geigerfurniture.com, 1 248 705 8788

Moveable Furnishings Specification

Project Name Rice University Brockman Hall for Opera	Date	4/21/2020
	Item	Guest Chair
	Item Tag	CH-3

Product	
Manufacturer /	OFS Cinque 108126
Product	
Description	Cinque 24x25.25x33.25 Mid-back guest chairs, 4-leg tubular metal base with nylon glides
Quantity:	





Finish	
Description	Fabric
Color	Geiger, Price Group 15, Striscia 1AY02 Cheyenne



Finish	
Description	Frame/Base Finish
Color	H1F Warm Grey

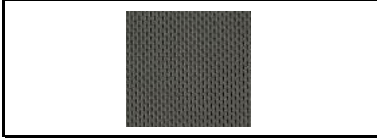

NOTES
Mike Denney, mike@mdi.design, 713.871.9009

Moveable Furnishings Specification	
Project Name Rice University Brockman Hall for Opera	Date 4/21/2020 Item Task Chair Item Tag CH-4
Product	
Manufacturer / Product Herman Miller Embody or Equal Description Embody Work Chair Standard Height Fully Adjustable Arm Hard Floor/Carpet Quantity: 21	
Finish	
Description Frame Finish Color G1 Graphite	
Finish	
Description Base Finish Color G1 Graphite	
Finish	
Description Fabric Seat/Back Color 3015 Rhythm Charcoal	
NOTES Other manufacturers products required to be approved as equals	

Moveable Furnishings Specification

Project Name	Rice University	Date	4/21/2020
	Brockman Hall for Opera	Item	Musician chair
		Item Tag	CH-5

Product	
Manufacturer / Product	Wenger Musician Chair
Description	Musician chair with folding tablet arms, 3 tablets to be left . Tablet arms are to be removable
Quantity:	30



Finish	
Description	Frame Finish
Color	Chrome

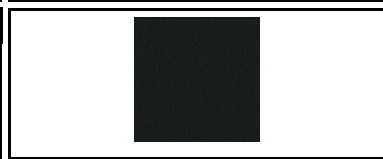



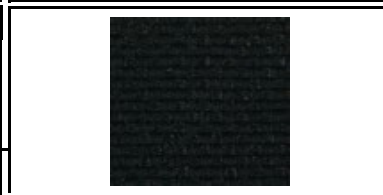

Finish	
Description	Upholstry Finsh
Color	Black



NOTES

Jodi Tuthill, jodi.tuthill@wengercorp.com, 1-800-4WENGER ext: 8182

Moveable Furnishings Specification	
Project Name Rice University Brockman Hall for Opera	Date 4/21/2020 Item Conference chair Item Tag CH-6
Product	
Manufacturer / Product Sit On It Novo 1033 BK1 F/e3 AR6 COM CS5 CH1 B21 MC23 FC13 AL3 LA4 KD Description SitOnit Novo task chair midbak Quantity: 14	
Finish	
Description Frame Finish Color Fog	
Finish	
Description Mesh Back Finish Color Fog	
Finish	
Description Upholstry Finish Color COM Geiger Striscia 1AY02 Cheyenne	
NOTES Clare Devlin, 832.570.3001, CDevlin@exemplis.com	

Moveable Furnishings Specification

Project Name	Rice University	Date	04/21/20
	Brockman Hall for Opera	Item	Chair
		Item Tag	CH-7

Product	
Manufacturer / Product	Herman Miller Caper WC410N or Equal
Description	Caper Stacking Chair Molded Seat No Arms
Quantity:	31





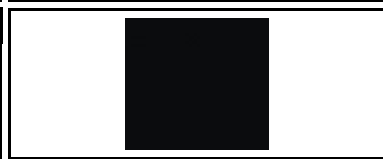

Finish	
Description	Frame Finish
Color	BK Black

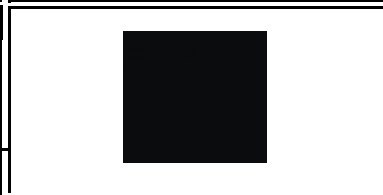

Finish	
Description	Seat/Back Finish
Color	BK Black

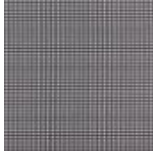

NOTES Other manufacturers products require to be approved as equals

Moveable Furnishings Specification	
Project Name Rice University Brockman Hall for Opera	Date 4/21/2020 Item Chair Item Tag CH-8
Product	
Manufacturer / Product Sit On It Novo 1033 BK1 F/e3 AR6 VG2 CS5 CH1 B17 MC20 FC1 AL3 LA1 KD Description SitOnIt Novo task chair Quantity: 4	
Finish	
Description Frame Finish Color Black	
Finish	
Description Mesh Back Finish Color Onyx	
Finish	
Description Seat Finish Color Element Onyx	
NOTES Clare Devlin, 832.570.3001, CDevlin@exemplis.com	

Moveable Furnishings Specification

Project Name	Rice University	Date	4/21/2020
	Brockman Hall for Opera	Item	Desk
		Item Tag	D-1

Product	
Manufacturer / Product	Allsteel, Knoll or Herman Miller
Description	72"x30" Veneer desk, 4 metal post legs, modesty, pencil drawer, power module 2power/2 usb
Quantity:	2

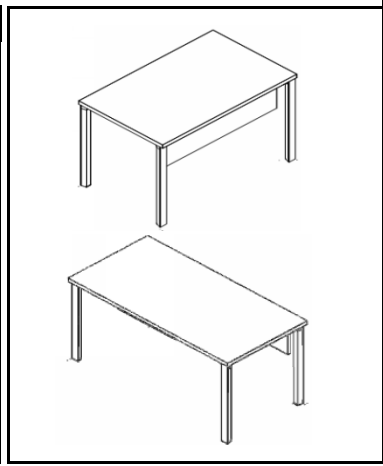

Finish	
Description	Top/Modesty Panel Veneer Finish
Color	EW Medium Matte Walnut



Finish	
Description	Base Finish
Color	G1 Graphite



NOTES

Other manufacturers products required to be approved as equals

Moveable Furnishings Specification

Project Name	Rice University	Date	4/21/2020
	Brockman Hall for Opera	Item	Desk
		Item Tag	D-2

Product	
Manufacturer / Product	OFS Impulse 5-6030FDP2
Description	Impulse G2 60X30 Double full pedestal desk, modesty breakfront, breakfront no inser, grommet, requires 2 lock cores
Quantity:	14



Finish	
Description	Veneer Finish
Color	C2Q Arabica



Finish	
Description	Era Pull Finish
Color	Black



NOTES

Mike Denney, mike@mdi.design, 713.871.9009

Moveable Furnishings Specification

Project Name	Rice University	Date	4/21/2020
	Brockman Hall for Opera	Item	Desk
		Item Tag	D-3

Product	
Manufacturer / Product	Allsteel, Knoll or Herman Miller
Description	72"x30" Veneer desk, 4 metal loop legs, modesty, pencil drawer, power module 2power/2 usb
Quantity:	3

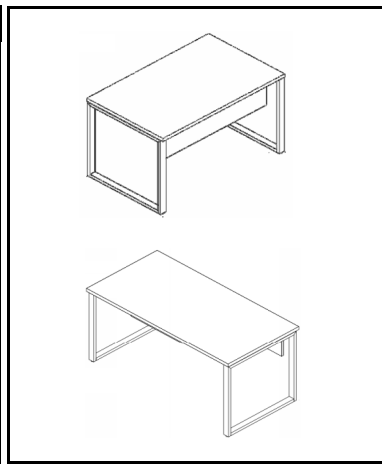

Finish	
Description	Top/Modesty Panel Veneer Finish
Color	EW Medium Matte Walnut



Finish	
Description	Base Finish
Color	G1 Graphite



NOTES
Other manufacturers products required to be approved as equals

Moveable Furnishings Specification

Project Name	Rice University	Date	4/21/2020
	RUMPAC - Brockman Hall for Opera	Item	Table
		Item Tag	F-1

Product	
Manufacturer / Product	Allsteel, Knoll or Herman Miller
Description	Lateral File Bar Pull Freestand painted metal Front 2 drawer 30" wide. Veneer common top
Quantity:	7



Finish	
Description	Top Finish
Color	EW Medium Matte Walnut



Finish	
Description	Base Finish
Color	G1 Graphite



NOTES
Other manufacturers products required to be approved as equals

Moveable Furnishings Specification

Project Name	Rice University	Date	4/21/2020
	Brockman Hall for Opera	Item	Files
		Item Tag	F-2

Product	
Manufacturer / Product	Allsteel, Knoll or Herman Miller
Description	Lateral File Bar Pull Freestanding painted metal front 4 Drawer, 36 Wide, bar pull
Quantity:	12



Finish	
Description	Base Finish
Color	G1 Graphite



NOTES Other manufacturers products required to be approved as equals

Moveable Furnishings Specification

Project Name	Rice University	Date	4/21/2020
	Brockman Hall for Opera	Item	Files
		Item Tag	F-3

Product	
Manufacturer / Product	Allsteel, Knoll or Herman Miller
Description	36"W x 68"H wardrobe cabinet, shelf and bar
Quantity:	1



Finish	
Description	Finish
Color	EW Medium Matte Walnut



NOTES Other manufacturers products required to be approved as equals

Moveable Furnishings Specification

Project Name	Rice University	Date	4/21/2020
	Brockman Hall for Opera	Item	Files
		Item Tag	F-4

Product	
Manufacturer / Product	Allsteel, Knoll or Herman Miller
Description	Mobile box/file pedestal, lockable, bar pull
Quantity:	1



Finish	
Description	Finish
Color	G1 Graphite



NOTES Other manufacturers products required to be approved as equals

Moveable Furnishings Specification

Project Name	Rice University	Date	4/21/2020
	Brockman Hall for Opera	Item	Lounge
		Item Tag	L-1

Product	
Manufacturer / Product	OFS Rowen 83041
Description	Rowen lounge w/arms 33.5x29.75x28.75, H5W Button Position - 3 position, brown buttons, metal legs, grade 15
Quantity:	1

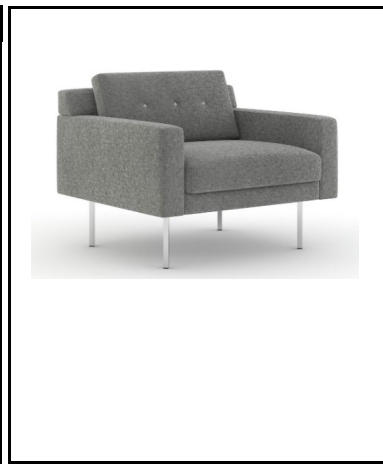

Finish	
Description	Leather
Color	Geiger Striscia 1AY02 Cheyenne



Finish	
Description	Base Finish
Color	H1F Warm Grey



NOTES

Mike Denney, mike@mdi.design, 713.871.9009

Moveable Furnishings Specification

Project Name	Rice University	Date	4/21/2020
	Brockman Hall for Opera	Item	Shelving
		Item Tag	SH-1

Product	
Manufacturer / Product	Global Industrial Metro Shelving
Description	Metro shelving, 24x36
Quantity:	15



Finish	
Description	Finish
Color	Stainless Steel



NOTES

Deloris Calhoun, dcalhoun@globalindustrial.com, (609) 223-6566 x166855

Moveable Furnishings Specification

Project Name	Rice University	Date	4/21/2020
	Brockman Hall for Opera	Item	Conference Table
		Item Tag	T-1

Product	
Manufacturer / Product	OFS Intermix TOP - CC-963204, BASE - CC-963206
Description	Intermix conference table, veneer, rectangular w/2" flat knife edge. 144"Wx59.5"Dx1.1875"H. Intermix base 104"Wx33"Dx28.75". Access panel
Quantity:	1

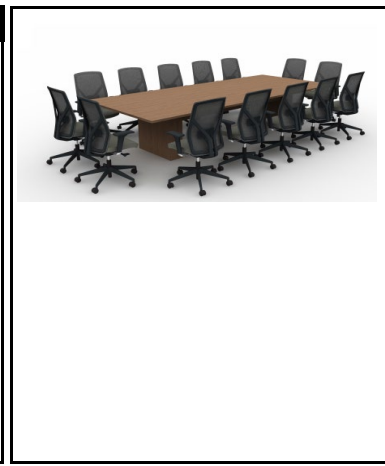

Finish	
Description	Veneer Finish
Color	C2Q Arabica



NOTES

Mike Denney, mike@mdi.design, 713.871.9009

Moveable Furnishings Specification

Project Name	Rice University	Date	4/21/2020
	RUMPAC - Brockman Hall for Opera	Item	Table
		Item Tag	T-2

Product	
Manufacturer / Product	Allsteel, Herman Miller or Knoll
Description	Rectangular table 24x24, veneer, post legs
Quantity:	1



Finish	
Description	Top Finish
Color	EW Medium Matte Walnut



Finish	
Description	Base Finish
Color	G1 Graphite



NOTES
Other manufacturers products required to be approved as equals

Moveable Furnishings Specification

Project Name	Rice University	Date	4/21/2020
	Brockman Hall for Opera	Item	Table
		Item Tag	T-3

Product	
Manufacturer / Product	Allsteel, Knoll or Herman Miller
Description	72x30 post led table
Quantity:	1



Finish	
Description	Top Finish
Color	EW Medium Matte Walnut



Finish	
Description	Base Finish
Color	G1 Graphite



NOTES

Other manufacturers products required to be approved as equals